

How to Measure Steering Cables

"Measure Twice. Order Once."

New Installation:

Measure cable routing path from wheel center line to engine connection, as follows:

- A = Center line of wheel to gunwale (or deck, if routed downward),
- B = Dash to transom,
- C = Gunwale to centerline of cable connection at centered tiller.

TYPICAL SINGLE STATION ROUTING

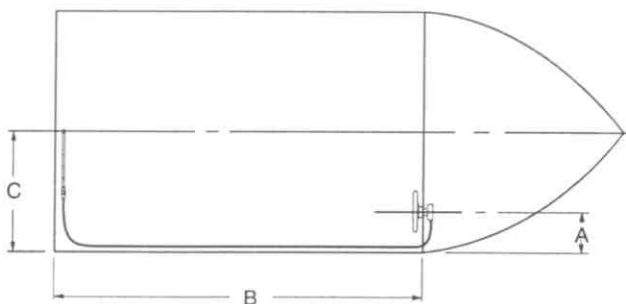

For Cable Installations through the Engine Tilt Tube:

Add A, B & C + 6", then round **up** to the next foot. Order that length cable.

For Cables Mounted to Transom, Splashwell or Stringer:

Add A, B & C, then subtract 6" and round **up** to the next foot. Order that length cable.

A single-cable, starboard drive push-pull mechanical cable system is shown in this diagram. If your mechanical system is different than the one depicted and/or you have any questions about mechanical steering after reviewing this guide, please contact Teleflex (Mechanical) Technical Service at (610)-495-7011 or www.teleflexmorse.com.

Cable routings (such as those found on pontoon boats) may vary from this drawing. Confirm length by laying a garden hose or similar object) along cable path and measure run from wheel to engine connection point.

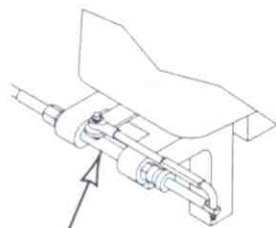

CABLE THROUGH ENGINE TILT TUBE

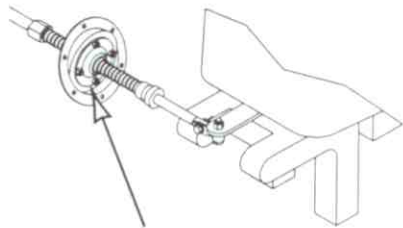

SPLASHWELL CABLE MOUNT

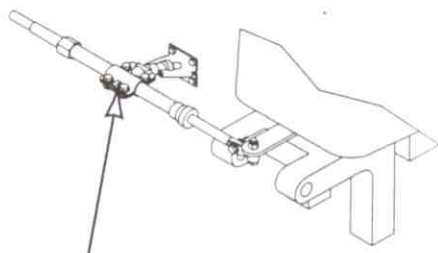

TRANSOM CABLE MOUNT (similar to stringer type)

Replacement of Existing Cable:

If possible, find the part number stamped on the plastic jacket of the old cable. If you removed the old cable, measure for the replacement cable as follows:



For Rotary Steering Cable Replacement, Measure Existing Cable as follows: Measure plastic cable jacket ("Y" dimension, shown in above drawing) in inches, add 18", and round **up** to next foot. Order that length cable.

For Rack Steering Cable Replacement, Measure Existing Cable as follows: Measure plastic cable jacket ("Y" dimension shown in above drawing) in inches, add 30", and round **up** to next foot. Order that length cable.

For JBS Jet Boat Cable Replacement, Measure Existing Cable as follows: Measure cable from tip to tip. (Round **up** to next foot if needed for whole foot.) Order that length cable.

If your engine does not have a tilt tube cable connection as shown at above, see "Connection Kits" pages in the back of this catalog to get the information or visit us on-line at www.teleflexmorse.com.

Control Cables

What to consider when selecting cables

Teleflex Marine makes engine control cables for a wide variety of applications. They recommend their use with Teleflex and Morse controls as well as in engine manufacturers' control systems.

Cables are available in three grades:

Standard cables are suitable for most applications with short, simple cable routings. **Mid range** cables are recommended for somewhat longer cable routings and heavier use than their standard counterparts. For difficult cable routings or anywhere uncompromising performance is needed, use **Premium** (TFXTREME) control cables.

OEM Replacement Type

These throttle/shift control cables are direct replacements for applications using engine makers' controls with proprietary cable interfaces, such as: Evinrude®, Johnson®, Mariner®, MerCruiser®, Mercury® Force® and some Volvo® engines. Most other engine makers use universal type cables (10-32 UNF threaded ends) and connection kits.

Universal 30 Series

Universal 30 series throttle/shift control cables are direct replacements for many boats using aftermarket controls or the following engine makers controls: Yamaha®, Honda®, Suzuki®, Tohatsu®, Volvo®, BMW®, Chrysler® and others. These are offered in five versions: one standard, three mid range and one premium (TFXTREME).

Universal 40 Series

Heavy duty universal type control cables are available in mid range and TFXTREME versions only.

How to Measure Control Cable Length

For initial installations, measure the distances A and B along an unobstructed path to the throttle and/or gear connection. Add A and B together then round up to the next cable length. That is the recommended length. Cable bends for most cables should not be less than 150mm radius. Cable bends using Supreme Cables can be as low as 100mm radius but it should be noted that tight radii increase friction. Care should be taken to avoid unnecessary cable bends because each bend adds to a cable's friction and lost motion. For outboard applications it is necessary to add an additional 600mm loop at the front of the engine to allow unrestricted steering movement. For replacement cable installations simply remove the cable from the boat and measure the cable as indicated to the right.

OUTBOARD

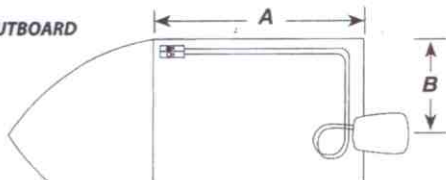

MEASURE CABLE PATH, ADD 600MM FOR LOOP & ROUND UP TO THE NEXT CABLE LENGTH (250MM OR 1 FOOT INCREMENTS)

INBOARD AND STERNDRIVE

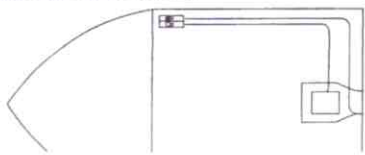

MEASURE CABLE PATH AND ROUND UP TO THE NEXT CABLE LENGTH (250MM OR 1 FOOT INCREMENTS)

CC189 Merc Gen II type



CC179 Merc/Mariner® 600A type



CC205 Johnson® Evinrude® 479 type



CC210 Mariner® 630 type



CC170 Johnson® Evinrude® 400 type



33C, SP33C, CC172, CC330, CC633 universal 30 series (10-32 UNF threaded ends)



33BC type (10-32 UNF threaded ends)



33B type (10-32 UNF threaded ends)



43C, CC693 (1/4" UNF threaded ends)



43BC type (1/4" UNF threaded ends)



43B type (1/4" UNF threaded ends)



Teleflex Marine control cables meet or exceed industry standards/ certification requirements and OEM specifications



CC172, CC330, CC633, 33C, SP33C, 43C, CC693



CC189



CC179



CC170

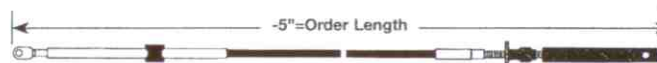

CC205



DO499



33LU Utility



33LC & 33LB Utility (33LC illus.)



33PC & 33PB Positive Lock (33PC illus.)



33VC & 33VB Vernier (33VB illus.)

Teleflex®
MARINE